

eduard
MASK

Lancaster 1/48

The die-cut mask for accurate canopy frame painting of the
Tamiya scale 1/48 KIT

EX 129

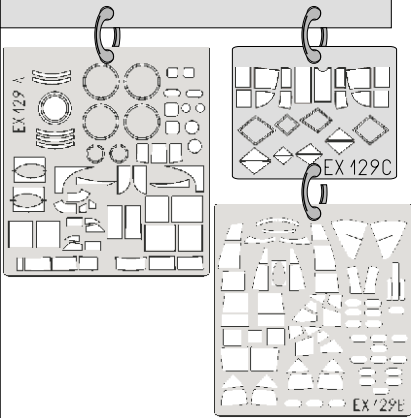

A28

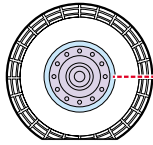

2pcs

B42



A29

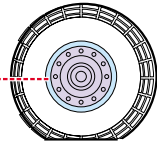

2pcs

B43



LIQUID MASK

F13

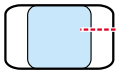

F14



F11 2pcs

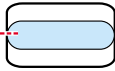

F3 2pcs



F9

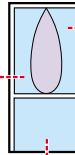

F10

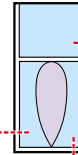

F19



F20



F5



F4



F16



3.)

F23

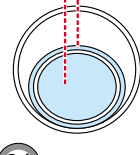

1.)

2.)

F1

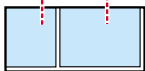

F2



F28

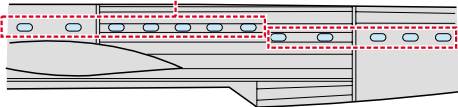

F15

F30

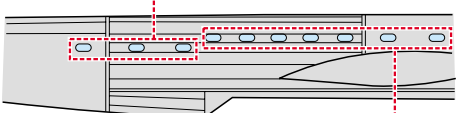

F29

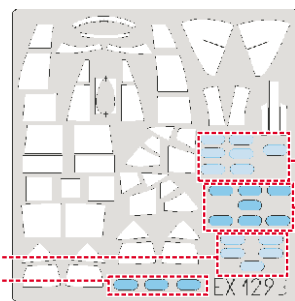

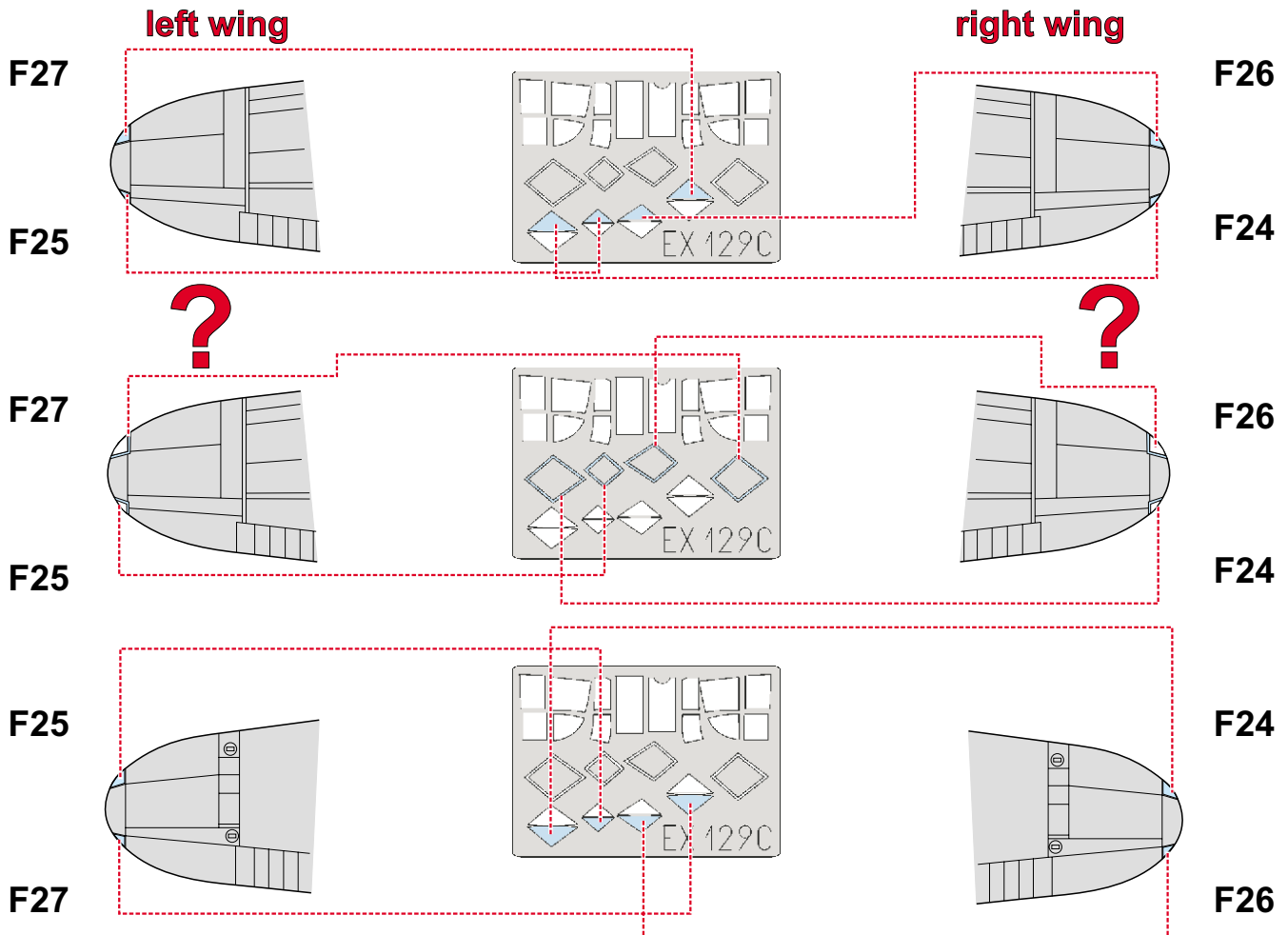
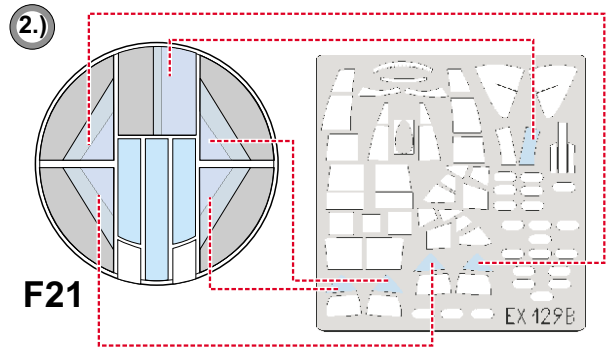
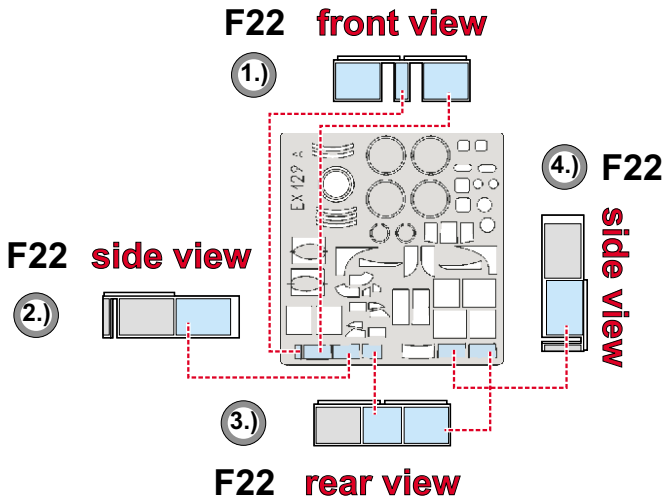
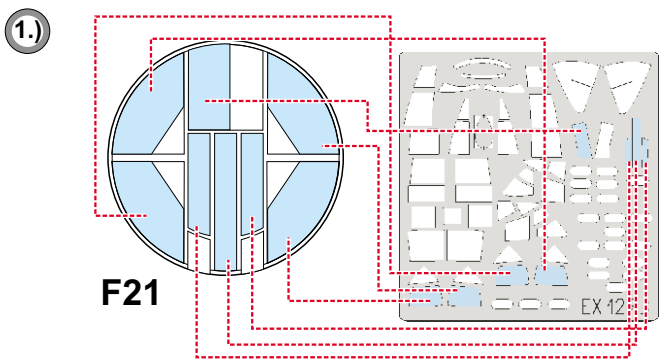
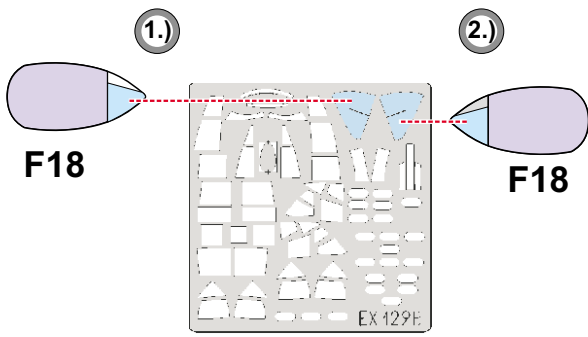

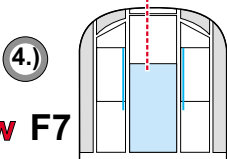
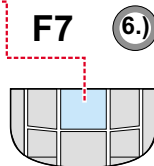
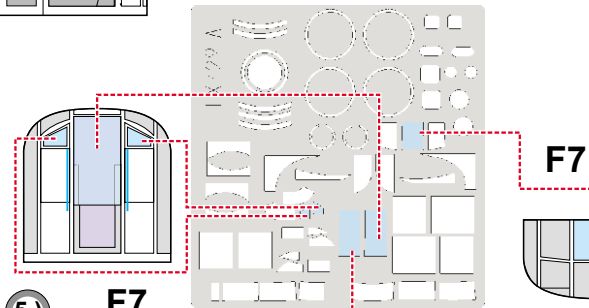
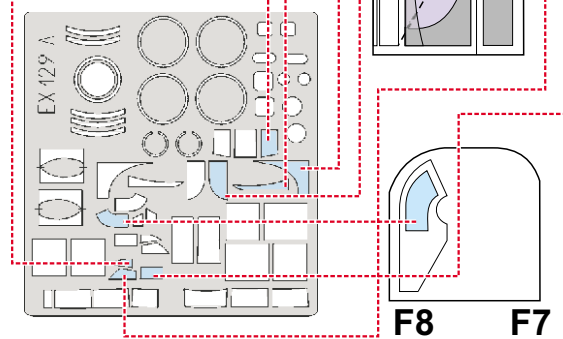
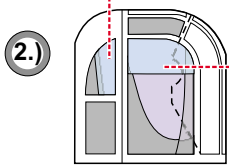
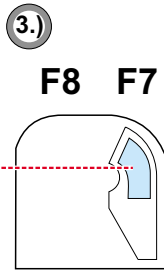
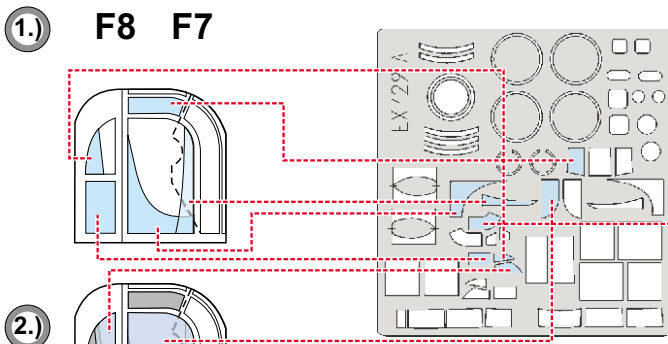
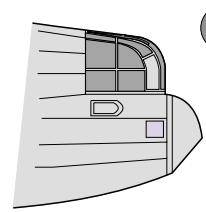
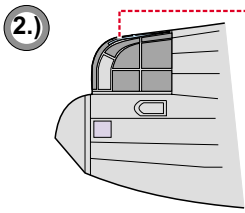
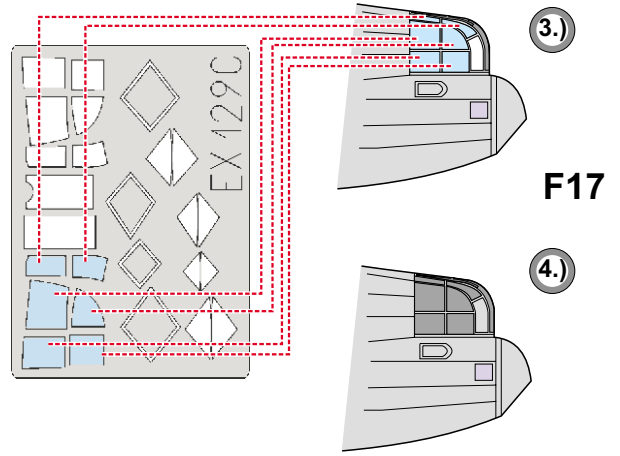
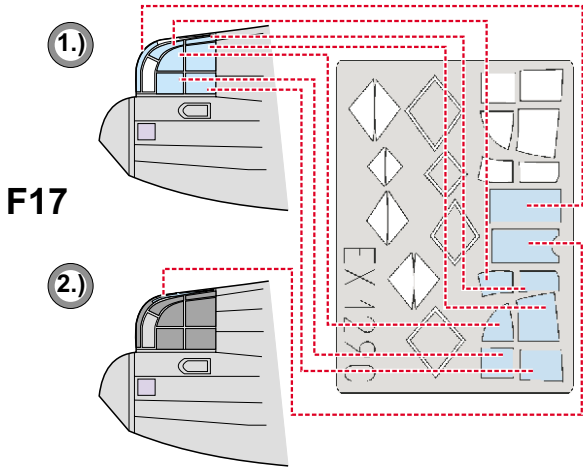
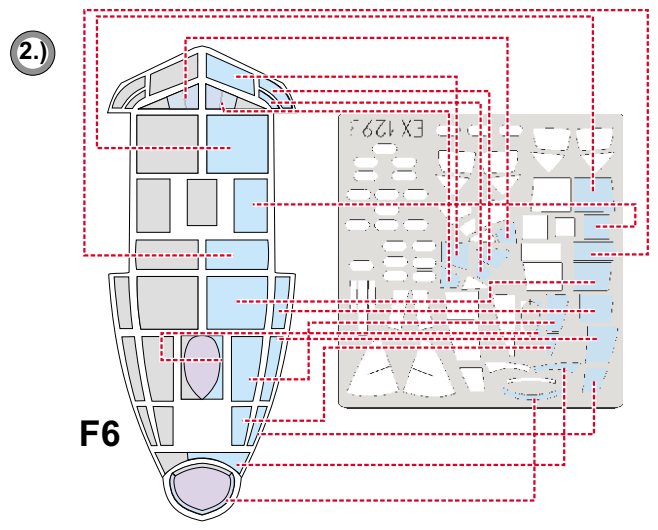
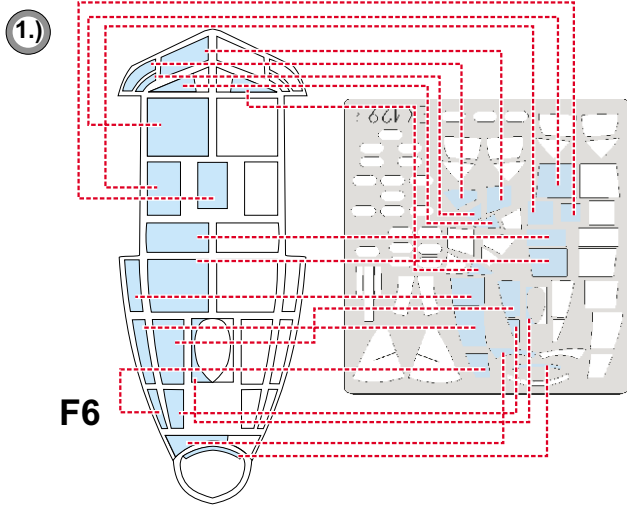

front view F7

REFERENCES:

- REPLIC#110/2001
- SQUADRON/SIGNAL PUBLICATIONS #1052
- THE AVRO LANCASTER(BY RICHRDS A.FRANKS)-SAM PUBLICATIONS